



## Room thermostat with Auto Timer, independent DHW RDE100.1 DHW

for heating systems

- Room temperature control
- 2-position control with On/Off output for heating
- Comfort, Economy, Auto timer and Protection mode
- Independent On/Auto/Off control of DHW
- Auto time switch
- Adjustable commissioning and control parameters
- Battery-powered DC 3 V (2 x 1.5 V AAA)

### Use

The RDE100.1DHW is used to control the room temperature in heating systems with independent control of DHW.

Typical applications:

- Residential apartments

For the control of the following plant components and of DHW:

- Thermal valves or zone valves
- Gas or oil boilers
- Fans
- Pumps

- Heat exchanger
- Continuous-flow water heater
- Small water heating systems

## Functions

- Room temperature control via built-in sensor
- Selection of operating mode with operating mode touchkey
- Setting auto time switch (individual day, 7 day or 5-2 day)
- Display of current room temperature or setpoint in °C or °F
- Touchkey lock (manually)
- Setpoint lock
- Periodic pump run
- Reloading factory settings for commissioning and control parameters
- Independent DHW and its auto time switch (individual day, 7 day or 5-2 day)

## Temperature control

The RDE100.1DHW acquires the room temperature with its built-in sensor and maintains the setpoint by delivering control commands. The switching differential is 1 K.

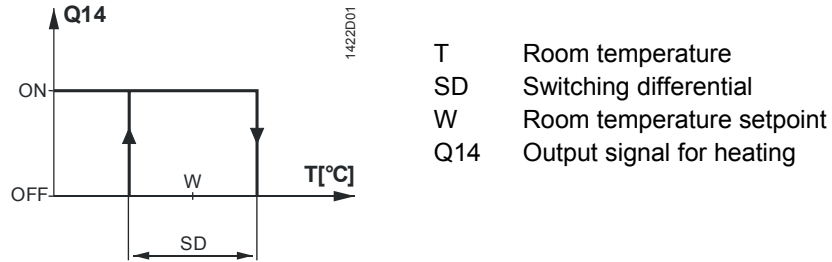

## Periodic pump run function

Can only be used when circulating pump or valve is controlled!  
 This function protects the pump or valve against seizing during longer off periods. Periodic pump run is activated for 3 minutes every 24 hours at 12:00.

Parameter	Pump status
P12 = 0 (Default)	Pump run off
P12 = 1	Pump run on

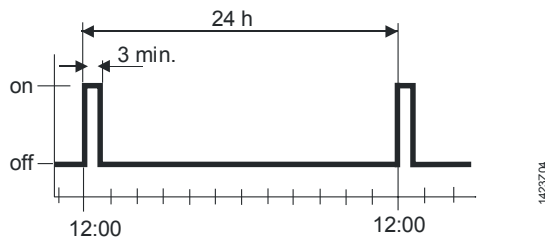

## Type summary

Product No.	Stock No.	Features
RDE100.1DHW	<b>S55770-T280</b>	Battery-powered DC 3 V







## Ordering

- When ordering, please indicate product No./stock No. and description
- Example:

Product No.	Stock No.	Description
RDE100.1DHW	<b>S55770-T280</b>	DHW room thermostat

- Valve actuators must be ordered separately

## Equipment combinations

Description		Product No.	Data Sheet
Electromotoric actuator		<b>SFA21..</b>	4863
Electrothermal actuator (for radiator valves)		<b>STA23..</b>	4884
Electrothermal actuator (for small valves 2.5 mm)		<b>STP23..</b>	4884
Damper actuator		<b>GDB..</b>	4634
Damper actuator		<b>GSD..</b>	4603
Damper actuator		<b>GQD..</b>	4604
Rotary damper actuator		<b>GXD..</b>	4622

## Mechanical design

The room thermostat consists of 2 parts:

- Plastic housing which accommodates the electronics, the operating elements and the room temperature sensor
- Mounting plate with screw terminals

The housing engages in the mounting plate and is secured with a screw.

## Operation and settings

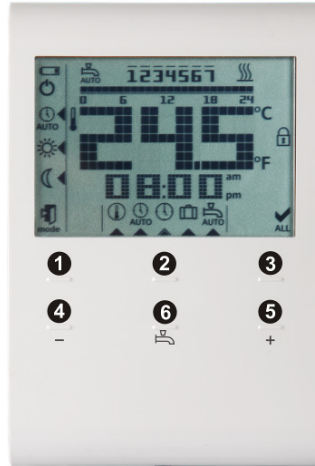





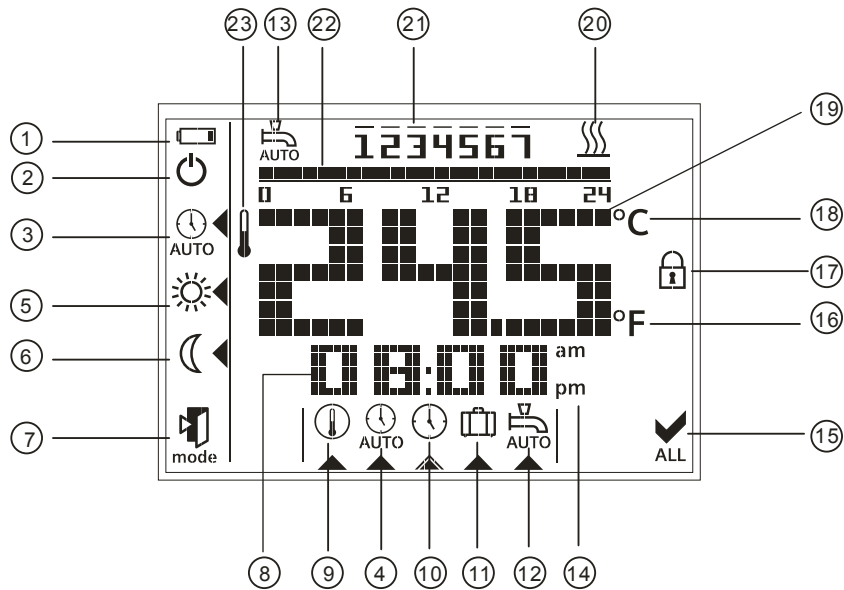







- 1) Operating mode touchkey
- 2) Set
- 3) Ok
- 4) Touchkey for decreasing a value
- 5) Touchkey for increasing a value
- 6) DHW switch On/Auto/Off touchkey

## Display



#	Symbol	Description	#	Symbol	Description
1		Indicating that batteries need to be replaced	12		View and set DHW auto time switch
2		Protection mode (protection mode symbol can be enabled via parameter settings).	13		DHW auto time switch activated
3		Auto timer mode	14	am pm	Morning: 12-hour format Afternoon: 12-hour format





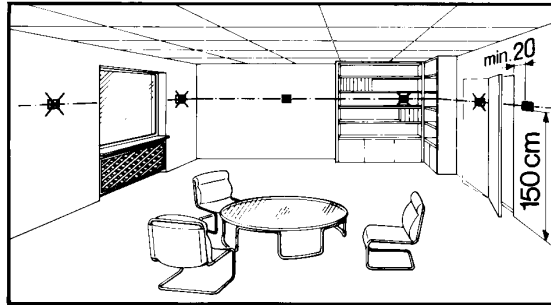

4		View and set auto time switch	15	 ALL	Confirmation
5		Comfort mode	16	°F	Room temperature in degrees Fahrenheit
6		Economy mode	17		Touchkey lock activated
7	 mode	Escape	18	°C	Room temperature in degrees Celsius
8		Display of time	19	245	Display of room temperature, setpoint, etc.
9		Permanent setpoint setting	20		Heating On
10		Day and time setting	21	1 2 3 4 5 6 7	Weekday 1 = Monday 7 = Sunday
11		Holiday mode setting	22		Timer bar (Alternative use as DHW timer bar)
			23		Current room temperature

## Mounting and installation notes

---

Do not mount the thermostat in niches or bookshelves, not behind curtains, not above or near heat sources, and not exposed to direct solar radiation. Mount about 1.5 m above the floor.



- Mounting**     
- Wiring**       
  
  
  

- Mount the thermostat in a clean and dry location without direct air flow from a heating/cooling equipment, and not exposed to drip or splash water  
See the Mounting Instructions M1429 enclosed with the thermostat.
  - Ensure that wiring, fusing and earthing comply with local regulations
  - Correctly size the cables to the thermostat and the valve actuators
  - Use only valve actuators rated for AC 24...230 V
  - The AC 230 V mains supply line must have an external fuse or circuit breaker with a rated current of no more than 10 A
  - Disconnect from power supply before removing the unit from its mounting plate

## Commissioning notes

---

- Commissioning**     After power is applied, the thermostat carries out a reset during which all LCD segments flash, indicating that the reset was made correctly. After the reset, the thermostat is ready for commissioning by qualified HVAC personnel.
- The control parameters of the thermostat can be set to ensure optimum performance of the entire system. Please refer to Operating Instructions CB1B1423, section "Do you want to change parameters?".
- Sensor calibration**     If the temperature on the display does not agree with the room temperature effectively measured, the temperature sensor can be recalibrated. For that purpose, adjust parameter P04.
- Setpoint lock**     We recommend reviewing the setpoint lock (for public areas) in parameters P06 and P08 and changing them as needed.
- Touchpad scanning rate**     Since the thermostat uses touch technology and to minimize battery power consumption, a parameter P21 (adjustable from 0.25 to 1.5 seconds) is implemented for the user to adjust. This function is only valid for the battery-powered version and the default value is 1 second.
- This means that when, for a certain time, the user does not touch the touchpad, the unit operates in power saving mode and the touchpad is running at a scanning rate of 1 second.
- (From the calculation – assuming 4 operations per day on the thermostat, the estimated 1-second scanning rate results in a battery life of 1 year. If the user increases the scanning rate, the batteries' life is extended.)

## Change of batteries

If the battery symbol  appears, the batteries are almost exhausted and should be replaced. Use alkaline batteries type AAA.

## Operating notes

---

The RDE100.1DHW provides Comfort, Economy, Auto timer and Protection mode. The difference between Comfort and Economy mode is only the room temperature setpoint. The changeover between Comfort, Economy and Protection mode is made either automatically by the auto time switch or by pressing touchkey **mode**.

### Comfort mode

When Comfort mode is activated, symbol  appears on the display. The setpoint (20 °C) can be readjusted by pressing touchkeys **+** and **-**.

### Economy mode

When Economy mode is activated, symbol  appears on the display. The setpoint (16 °C) can be readjusted by pressing touchkeys **+** and **-**.

### Protection mode

If the temperature falls below 5 °C, the unit automatically activates the heating output. The symbol  appears only, if the icon is enabled via parameter settings.

### Holiday mode

When holiday mode is activated, symbol  appears on the display. The setpoint (12 °C) and the number of days a user is away can be readjusted by pressing touchkeys **+** and **-**.

### Time switch AUTO





When Auto timer mode is enabled, the changeover between the operating modes (Comfort and Economy mode) will take place automatically. There are three options for time switch setting: individual day, 7 day or 5-2 day. You can select Comfort or Economy mode in every 15 minutes interval of the day. The 0:00 to 24:00 hour time bar will allow you to set the mode throughout the selected day(s).

Factory default for 7-day Time switch

Default value	Day/s	Comfort mode	Economy mode
	Mo (1) – Fr (5)	6:00 – 8:00 hr	22:00 – 6:00 hr
		17:00 – 22:00 hr	8:00 – 17:00 hr
	Sa (6) – Su (7)	7:00 – 22:00 hr	22:00 – 7:00 hr

Please refer to Operating Instructions CB1B1423, section "Do you want to enter your own Time switch?".

### DHW and DHW auto timer function AUTO

Press  to switch on DHW heating. Press this  touchkey again, DHW will be in the auto status, this  symbol will be shown. Press this  touchkey one more time, DHW heating will be switched off and no symbol will be shown.

Please refer to Operating Instructions CB1B1423, section "Do you want to activate DHW control?".

During auto status, the DHW will switch according to the DHW time switch set. DHW can be selected on or off in every 15 minutes interval of the day. The 0:00 to 24:00 hour time bar will allow you to set DHW on or off throughout the selected day(s).

Factory default for 7-day Time switch for DHW

Default value	Day/s	DHW control ON	DHW control OFF
	Mo (1) – Fr (5)	6:00 – 8:00 hr	22:00 – 6:00 hr
		17:00 – 22:00 hr	8:00 – 17:00 hr
	Sa (6) – Su (7)	7:00 – 22:00 hr	22:00 – 7:00 hr

Please refer to Operating Instructions CB1B1423, section "Do you want to enter your own Time switch for DHW control?".

## Maintenance notes

---

The thermostats are maintenance-free.

## Disposal

---



In terms of disposal, the room thermostats are classified as electronic scrap conforming to the European Directive 2011/65/EU (WEEE) and must not be disposed of as unsorted domestic waste. The relevant national legal regulations must be complied with and the units must be disposed of via the appropriate channels. Local and currently valid legislation must be observed.

## Technical data

---



### Power supply

Operating voltage  
• RDE100.1DHW DC 3 V (2 x 1.5 V alkaline batteries AAA)

For battery life (RDE100.1DHW), see below (alkaline batteries type AAA).  
Battery life calculation is based on the touchpad scanning rate during idle time (assuming a user presses 4 touchkeys per day):

Scanning rate 0.25 s	193 days battery life
Scanning rate 0.50 s	273 days battery life
Scanning rate 1.00 s	345 days battery life
Scanning rate 1.50 s	378 days battery life

Control inputs	Control input Q11-Nx (Com)	(AC 24...230 V)	max. 5(2) A	min. 8 mA
	Control input Q21-Nx (Com)	(AC 24...230 V)	max. 5(2) A	min. 8 mA

Control outputs	Heating valve or wall-hung boiler			
	Control output Q12-Nx (NC contact)	(AC 24...230 V)	max. 5(2) A	min. 8 mA
	Control output Q14-Nx (NO contact)	(AC 24...230 V)	max. 5(2) A	min. 8 mA

Function data	DHW heating equipment			
	Control output Q22-Nx (NC contact)	(AC 24...230 V)	max. 5(2) A	min. 8 mA
	Control output Q24-Nx (NO contact)	(AC 24...230 V)	max. 5(2) A	min. 8 mA



Switching differential SD	1 K
Comfort mode	20 °C (5...35 °C)
Economy mode	16 °C (5...35 °C)
Holiday mode	12 °C (5...35 °C) (Standalone)

Built-in room temperature sensor	
Setpoint setting range	5...35 °C (Comfort/Economy mode)
Accuracy at 25 °C	< ±0.5 K
Temperature calibration range	±3.0 K

Resolution of settings and displays	
Setpoints	0.5 °C
Temperature value displays	0.5 °C

Environmental conditions	Operation	As per IEC 60721-3-3
	Climatic conditions	Class 3K5
	Temperature	0...50 °C
	Humidity	<95% r.h.



Norms and standards	Transport	As per IEC 60721-3-2
	Climatic conditions	Class 2K3
	Temperature	-25...60 °C
	Humidity	<95% r.h.
	Mechanical conditions	Class 2M2
	Storage	As per IEC 60721-3-1
	Climatic conditions	Class 1K3
	Temperature	-25...60 °C
	Humidity	<95% r.h.
	CE conformity to	
EMC directive	2004/108/EC	
Low voltage directive	2006/95/ EC	
General	 C-Tick conformity to	
	EMC emission standard	AS/NSZ 4251.1:1999
	 RoHS (Restriction of Hazardous Substances)	2011/65/EU
	Product standards	
	Automatic electrical controls for household and similar use	General requirements EN 60730-1 Particular requirements for temperature sensing controls EN 60730-2-9
	Electromagnetic compatibility	
	Emissions	EN 61000-6-3
	Immunity	EN 61000-6-2
	Safety class	II as per EN 60730-1, EN 60730-2-9
	Pollution class	II as per EN 60730
Degree of protection of housing	IP30 as per EN 60529	
Connection terminals for	Solid wires or prepared stranded wires 2 x 1.5 mm <sup>2</sup> or 1 x 2.5 mm <sup>2</sup> (min. 0.5 mm <sup>2</sup> )	
Weight	0.167 kg	
Color of housing front	RAL9003	

## Connection diagrams

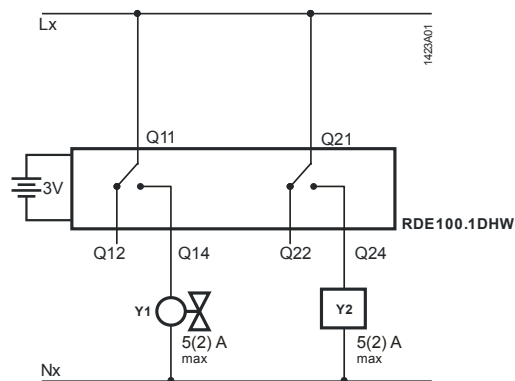

## Legend

Lx	Live, AC 24...230 V
Nx	Neutral conductor, AC 24...230 V
Y1	Heating valve or wall-hung boiler
Y2	DHW heating equipment

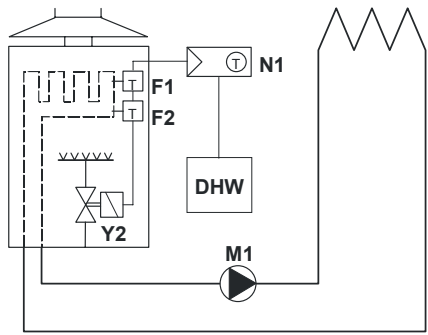

Room thermostat with direct control of a gas-fired wall-hung boiler and independent control of DHW

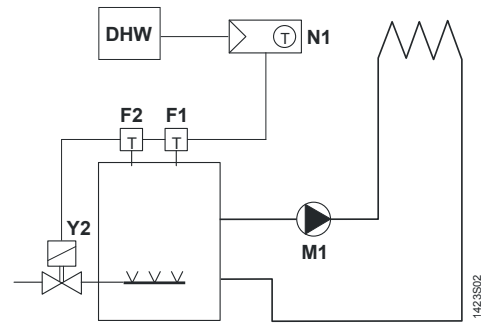

Room thermostat with direct control of a gas-fired floor-standing boiler and independent control of DHW

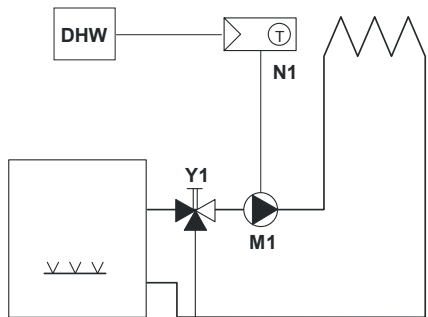

Room thermostat with direct control of a heating circuit pump (precontrol by manual mixing valve) and independent control of DHW

Legend

- F1 Thermal reset limit thermostat
- F2 Safety limit thermostat
- M1 Circulating pump
- N1 RDE100.1DHW room thermostat
- Y1 Mixing 3-port valve with manual adjustment
- Y2
- DHW Magnetic valve
- DHW DHW heating equipment

## Dimensions

All dimensions in mm

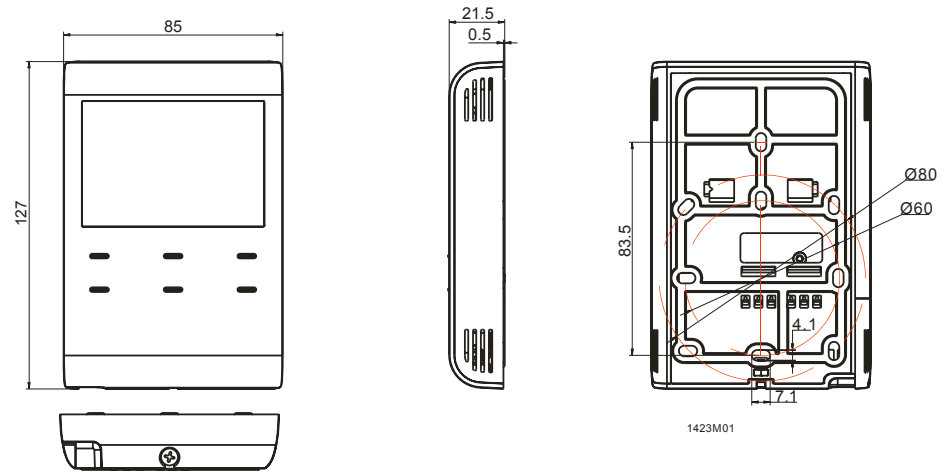

## Remarks

### Heating:

Because of the unavoidable self heating effects of the electrical current, any loads of more than 3 Amperes connected to the unit can influence the control behavior and temperature accuracy in a negative way.