



OpenAir™

Handheld tool for VAV compact controller

AST10

Serie E

The handheld tool is used for setting and displaying the parameter values in connection with the following types of devices:

- VAV compact controller GDB181.1E/3 and GLB181.1E/3 to series D
- VAV modular controller ASV181.1E/3 to series D

With limitations:

- VAV compact controller GDB181.1E/3 and GLB181.1E/3 as of series E
- VAV modular controller ASV181.1E/3 as of series E
- VAV compact controller KNX/PL-Link GDB181.1E/KN and GLB181.1E/KN

Ordering and delivery

When ordering, please provide the name and type reference:

Handheld tool **AST10**

The unit is delivered together with three separate (3-wire) connecting cables in a solid case.

Note

Naming conventions In the following, the designation VAV compact controller applies equally to the actual VAV compact controller G..B181.1E/.. as well as the VAV modular controller ASV181.1E/3.

Mode of operation

The handheld tool is powered and the communication link between unit and VAV compact controller is established via one of the enclosed 3-wire connecting cables. When power is turned on, the AST10 is ready for operation after about 5 seconds, that is, the parameters can be set and read. The LCD displays "Srch" both during the time communication is opened – on startup – and when communication is interrupted.

When a setting was changed, it can be saved in the VAV compact controller by pressing the "Set" button.

When pressing the "Factory settings" button, the OEM factory settings will be retrieved. If, in place of the factory settings, the Siemens default settings appear, they were not overwritten by the manufacturer of the air volume controller. In the event of communication problems with VAV compact controller, the LCD displays "Err".

The LCD displays the available functions as follows:

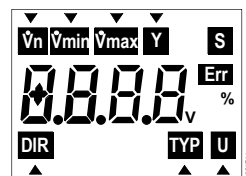

Figure 1

Parameter symbols and their meaning

Symbol	Meaning	Value range
\dot{V}_n	Display of key variables for nominal volumetric airflow; set by manufacturer (OEM)	1...2,55 in increments of 0.01 Siemens factory setting: 1,00
\dot{V}_{min} [%]	Setting or display of minimum volumetric airflow	-20...100 % in increments of 1 % Siemens factory setting: 0 %
\dot{V}_{max} [%]	Setting or display of maximum volumetric airflow	20...120 % in increments of 1 % Siemens factory setting: 100 %
Y [V]	Setting and display of setpoint of volumetric airflow	0...11 V in increments of 0.05 V
DIR	Setting or display of direction of rotation	Possibilities: r = Clockwise L = Counterclockwise Siemens factory setting: r
TYP	Setting or display of operating mode	Possible settings: con, 3P Siemens factory setting: con
U [V]	Display of actual value of volumetric airflow	0...12.8 V in increments of 0.05 V
S	Display of zero point calibration (applies only to devices through series D).	Symbol blinks in display mode U and Y

Mechanical design

The unit is portable and has been designed for use on site. It consists of two parts: plastic housing and aluminum plate. Both are connected via a snap-on mechanism and can easily be separated. The housing accommodates an electronic circuit board, setting buttons, LCD and a connecting cable. The separate cables have a connector at one end and ferrules or a 6- or 7-pin plug at the other. All wires are color-coded and labeled (refer to "Technical data"). The cable is connected to the handheld tool via the plug on the bottom of the device.

Setting, display, and connection elements

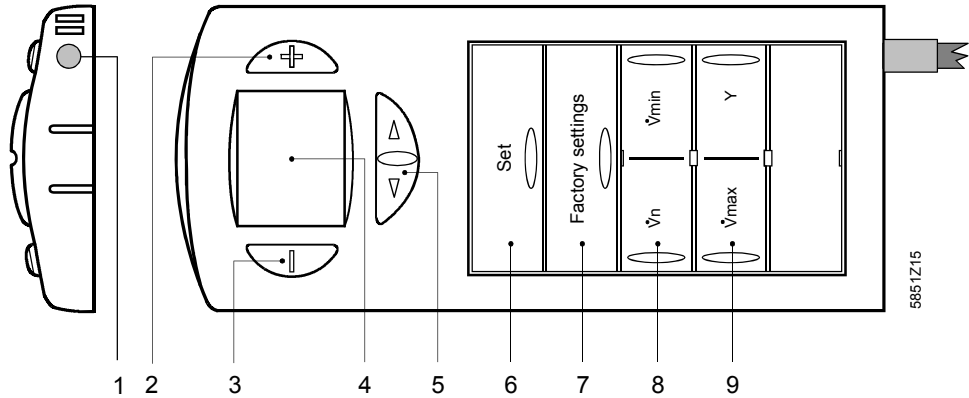

- 1 Connection cable
- 2 Button for setting a higher parameter value
- 3 Button for setting a lower parameter value
- 4 LCD
- 5 Toggle button for selecting parameter DIR, TYPE or U ¹⁾
- 6 Storage button
- 7 Reset button "Factory setting"
- 8 Toggle button for selecting parameter \dot{V}_n or \dot{V}_{min} ²⁾
- 9 Toggle button for selecting parameter \dot{V}_{max} or Y ²⁾

¹⁾ The selected parameter is indicated on the bottom line of the LCD by means of a cursor (▲) (Figure 1).

²⁾ The selected parameter is indicated on the top line of the LCD by means of a cursor (▼) (Figure 1).

Accessories (included in the delivery)

Description	Length	Part number
Connecting cable with 3-pin socket and ferrules	1 m	74 424 0125 0
Connecting cable with 3-pin socket and 6-pin plug, up to and including series D	2.5 m	74 424 0126 0
Connecting cable with 3-pin connector and 7-pin plug, as of series E	2.5 m	74 424 0301 0

Disposal

The larger plastic components are labeled as per ISO/DIS 11 469 for environmentally compatible disposal.

Mounting notes

When using the connecting cable with the 6- or 7-pin plug, attach the tension relief band at the cable to the VAV compact and modular controllers as shown in the following illustration.

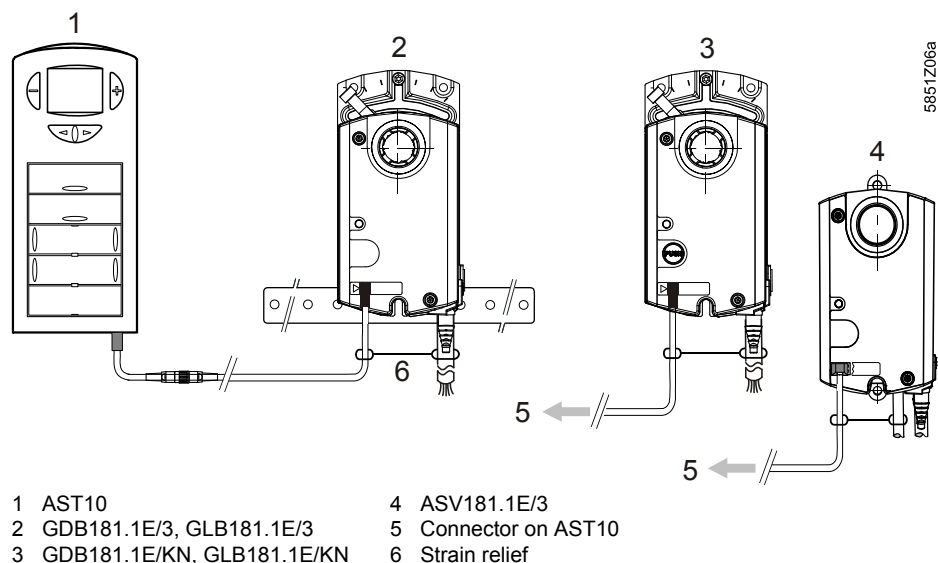

- | | |
|------------------------------|----------------------|
| 1 AST10 | 4 ASV181.1E/3 |
| 2 GDB181.1E/3, GLB181.1E/3 | 5 Connector on AST10 |
| 3 GDB181.1E/KN, GLB181.1E/KN | 6 Strain relief |

Technical data

Power supply G, G0	Operating voltage	AC 24 V \pm 20 %.
	Safety extra low-voltage (SELV) (PELV) as per requirements for external Safety isolation transformer (100 % time on)	HD 384 EN 60742
	Supply line fusing	Max. 6 A
	Frequency	50/60 Hz
	Power consumption	3 VA
Signal input/output	Communications signal type	PPS2
Communications signal YC	Protecting against incorrect connection	Max. AC 24 V
⚠ Housing protection type and -Safety class	Protection class as per EN 60529	IP30
Environmental conditions	Insulation class as per EN 60730	III
Standards and guidelines	Operating/Transport	IEC 721-3-3 / IEC 721-3-2
	Climatic conditions	Class 3K5 / Class 2K3
	Temperature	0...50 °C / -25...70 °C
	Humidity (non-condensing)	<85 % r.h. / <95 % r.h.
Weight	Mechanical conditions	Class 2M2
	Product standards	
	Automatic electronic controls for Household and similar use	EN 60730-2-14 (Mode of operation, type 1)
	Electromagnetic compatibility	
	Immunity	EN 61000-6-2
	Emissions	EN 61000-6-3
	CE conformance	
	EMC directive	2004/108/EC
	C-Tick conformity	
	Emissions	AS/NZS 61000-6-3
Weight	Without packaging	0.17 kg
Connecting cable	Cable type, number of wires and diameter	VDE Li-YY, 3-wire 0.34 mm ²
	Cable length for cable with 6 or 7-pin plug	Ca. 2.5 m
	Cable length for cables with ferrules	Ca. 1 m

Diagrams

Wiring coding

Connection cable with ferrules (color coded and labeled):

Wiring labeling	Wire color	Terminal code	Meaning
1	Brown (BR)	G	System potential AC 24 V
2	White (WT)	G0	System zero AC 24 V
8	Green (GR)	UC/YC	Communications signal

Internal diagram

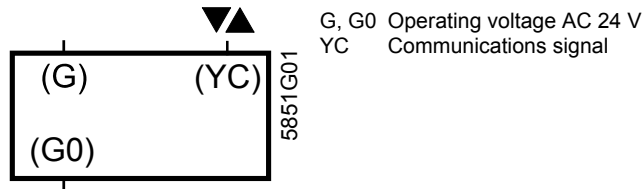

Connection diagrams

Example with connecting cable 74 424 0125 0

With VAV compact controller as of series B

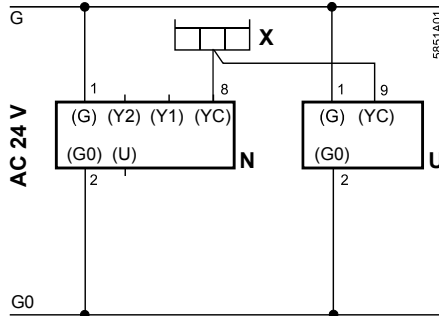

N VAV compact controller
 U Handheld tool AST10
 X Terminal strip, e.g. in the panel

With VAV compact controller as of series A

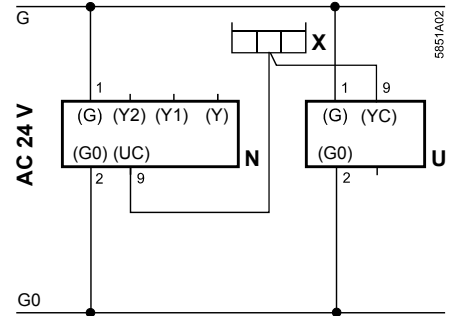

Dimensions

AST10

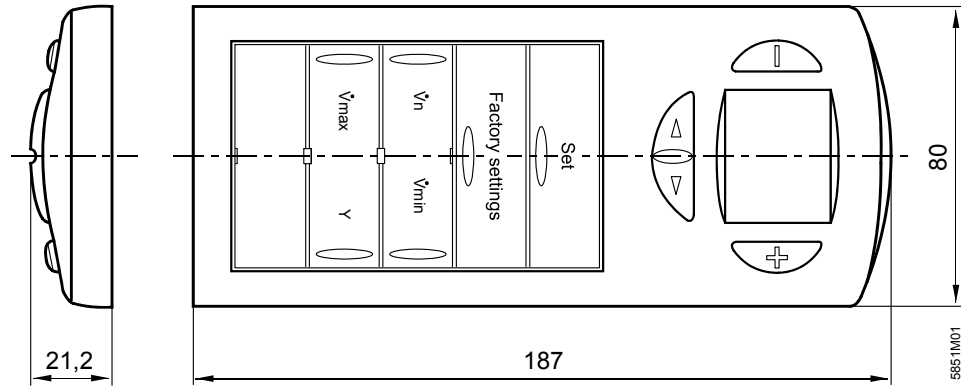

74 424 0125 0

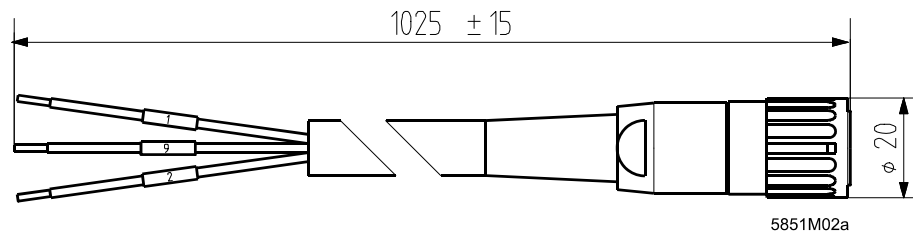

74 424 0126 0

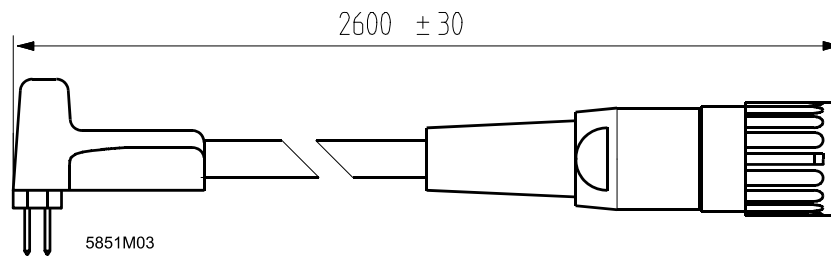

74 424 0301 0

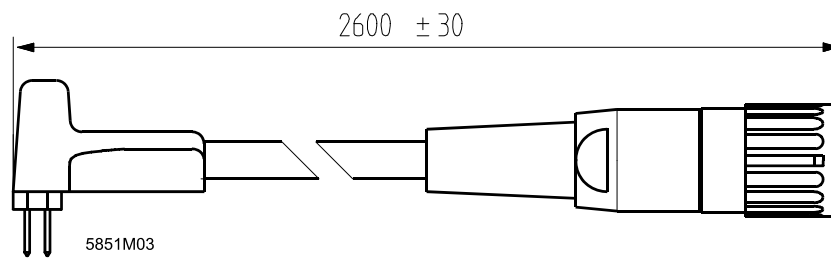

Dimensions in mm