

## Room thermostat with 24-hour time switch and large LCD

RDJ100



### Programmable, for heating systems

- 2-position or PID control to switch on/off heating systems
- Operating modes: Automatic, Comfort, Energy saving, and Frost protection
- 24-hour time switch
- Service interval reminder
- Large LCD display
- Minimum and maximum setpoint limitation
- Battery powered: 2 x alkaline type AA batteries, 1.5 V

The device is used to control the room temperature in heating systems.

Typical applications:

- Homes
- Residential buildings
- Schools
- Offices

The device is used together with the following equipment:

- Thermal valves or zone valves
- Combi boilers
- Gas or oil burners
- Pumps

### Temperature control

RDJ100 offers both 2-position and PID intelligent learning temperature control, configurable via parameter P01 (control behaviour).

2-position control algorithm to switch on and off the heating system within a switching differential (SD) as per the difference between setpoint setting and measured room temperature.

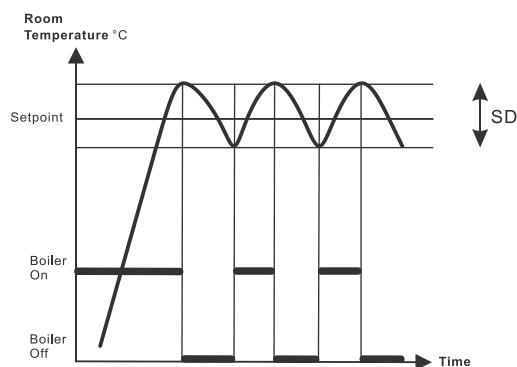

PID intelligent learning control algorithm periodically switches on and off the heating system. The period time (T) and pulse length (P) of the control signal (PWM) are determined by the setpoint and the measured room temperature.

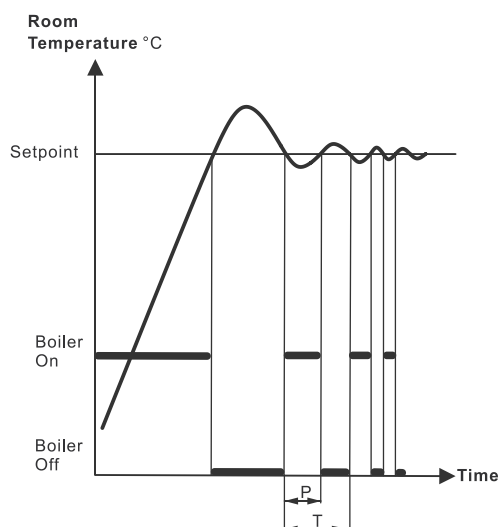

In general, PID control provides more comfort and is more energy efficient than 2-position control.

## Control behaviour (P01)

The factory setting for control is "PID slow", ideal for most heating systems. Optimum control can be selected if control does not provide the desired result:

### 2-position, 1 K

2-position controller with 1 [K] switching hysteresis

- For systems with small capacity that appear slow
- For applications requiring extended runtimes or where frequent switching causes problems
- For difficult control loops where hunting may result

Typical applications:

- Dry floor heating systems
- Heat pumps
- Electric heating with contactors

### 2-position, 0.5 K

- 2-position controller with 0.5 [K] switching hysteresis.
- For general control situations. Provides better comfort than 1 [K] switching hysteresis.
- Can also be used for difficult control situations.

### PID slow

PID control behaviour for slow heating systems that require longer minimum On times and a limited number of switching cycles per hour.

Typical applications:

- Wet floor heating systems, oil fired boilers
- Can also be used for all other types of heating applications. (Alternative setting)

Minimum switch on/off time	> 4 minutes
Minimum period	Approximately 12 minutes

### PID fast

PID control behaviour for fast heating systems that tolerate a high number of switching cycles.

Typical applications:

- Electric heaters with current valve
- Gas boilers
- Fast thermal actuators

Minimum switch on/off time	> 1 minute
Minimum period	Approximately 6 minutes



#### **⚠ WARNING**

Do not use PID fast for oil boilers or electric mechanical actuators!





## Backup

When removing the batteries, the setpoints and information required for operating mode changeover are retained for max. 2 minutes.

## Operating modes

The device has the following modes: Automatic, Comfort, Energy saving and Frost protection.

Move the operating mode slider to the respective position to select another operating mode.

Automatic mode	Automatic mode is active when symbol  is displayed. The device operates as the selected 24-hour time program.
Comfort mode	Comfort mode is active when symbol  is displayed. The device controls to the temperature setpoint adjusted at $T_{\text{Sun}}$ . This setpoint can be adjusted by setting the program slider to $T_{\text{Sun}}$ .
Energy saving mode	Energy saving mode is active when symbol  is displayed. The device controls to the temperature setpoint adjusted at $T_{\text{Moon}}$ . This setpoint can be readjusted by setting the program slider to $T_{\text{Moon}}$ .
Frost protection	Frost protection is active when symbol  is displayed. The device controls to the preset temperature setpoint for frost protection.



## Commissioning notes

### Parameter list

Parameter	Description	Factory setting	Setting range	Remark
P01	Control behavior	PID slow (4)	0 = 2P, 1.0 K 1 = 2P, 0.5 K 2 = PID fast 4 = PID slow	
P02	Maximum temperature range	30 °C	P03...30 °C	Limit of comfort and economy setpoint
P03	Minimum temperature range	5 °C	5 °C...P02	Limit of comfort and economy setpoint
End	Exit parameter setting			

### Parameter setting

The parameter setting remains in non-volatile memory and is not erased when the battery is removed. The reset function on the rear of the thermostat reloads the factory settings.

	<p><b>Parameter setting mode</b></p> <ol style="list-style-type: none"> <li>1. Press RESET on the rear for 5 seconds until “P01” appears. Note: Pressing the button longer than 10 seconds resets the thermostat.</li> <li>2. Press RESET again, the parameter value on the second line flashes and is ready for adjustment.</li> <li>3. Adjust the parameter using setting knob.</li> <li>4. Press RESET once to confirm the setting.</li> <li>5. Rotate the setting knob clockwise to next parameter and repeat steps 2 to 4.</li> <li>6. Exit the parameter setting mode by rotating the setting knob clockwise to “End” and pressing RESET once.</li> </ol>
	
	

Note: The thermostat automatically exits parameter setting mode one minute after the last action.

## Display

The digital display shows the current room temperature, the ON/OFF times as well as the symbol for the currently active operating mode which is currently active. When the heating output is active, the triangle symbol is displayed.



## Service interval reminder

The service interval reminder function is an aid to carry out a safety check on the boiler at regular intervals.

If service interval function has been enabled on thermostat and the pre-warning time is reached, the display shows message “SEr” with the number of remaining days until service is due. The pre-warning will appear up to 50 days prior to its next service.



If the message “SEr...DuE” appears, it indicates that the thermostat has past the service day. Depending on the setting of the service reminder function, the thermostat will either only display a warning or switch off (frost protection).

In case the service reminder function is switched off, the display will show “OFF”. Then the thermostat can only be activated manually for 60 minutes by turning the setting knob or pressing the advance button. The thermostat will control under comfort mode regardless of the selected operating mode (automatic, comfort or energy saving).

If service interval function is enabled and operating mode selector is set to Standby mode or set to other mode from Standby mode, the screen will display the remaining days until next service due.

The service interval reminder can be enabled and reset by a service professional.

## Equipment combinations

Description		Product number	Data sheet *)
Electrothermal actuator (for radiator valves)		STA23..	4884
Electrothermal actuator (for small valves 2.5mm)		STP23..	4884
Electromotoric actuator		SFA21..	4863

\*) The documents can be downloaded from <http://siemens.com/bt/download>.

## Ordering

When ordering, specify both name and product number e.g. room temperature controller RDJ100.

Order valves and actuators as separate items.

## Mechanical design



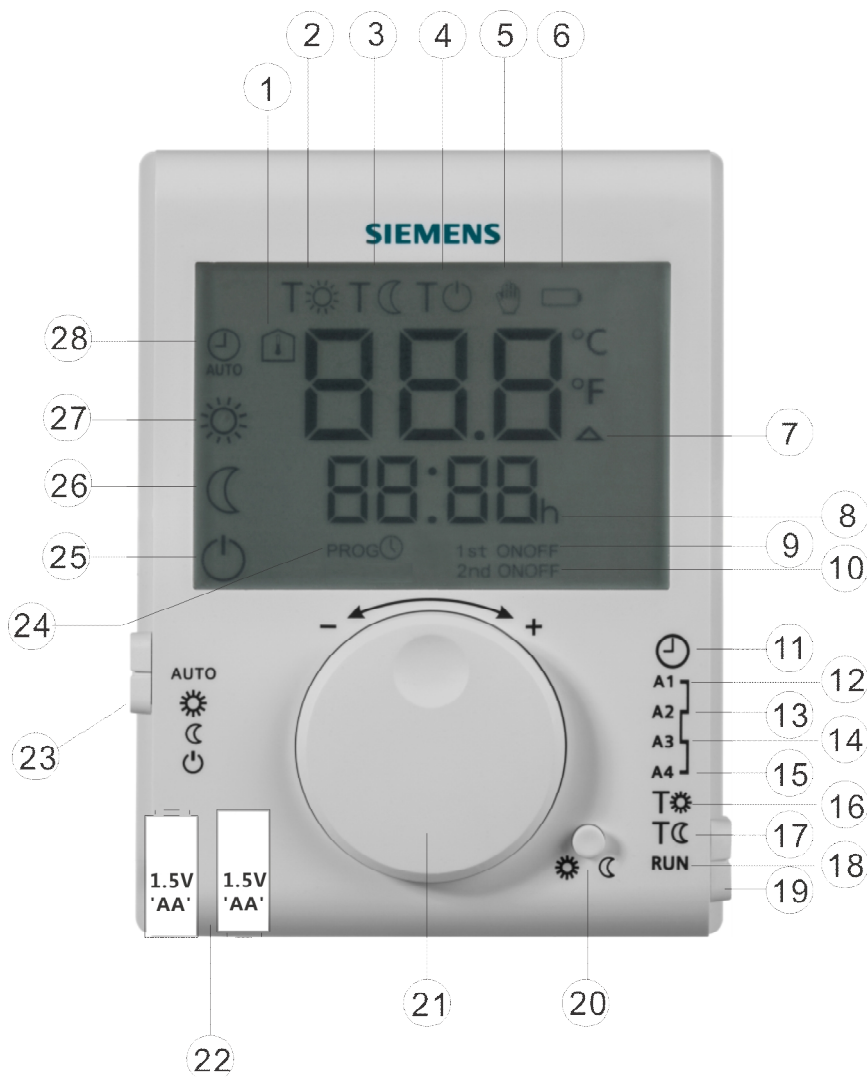

The device consists of 3 parts:

- Plastic housing with digital display containing the electronics, operating elements, and built-in room temperature sensor
- Baseplate (mounting base)
- Battery compartment

The housing engages in the baseplate and snaps on. The baseplate carries the screw terminals. There is a reset button on the rear of the device.



RDJ100 Elements	Functions
1	Room temperature display in °C
2	The device controls to the adjusted comfort temperature setpoint
3	The device controls to the adjusted energy saving temperature setpoint
4	The device controls to the preset frost protection temperature setpoint
5	Setpoint temporarily overridden until the next switching time
6	Indicates low battery power; replace batteries
7	Indicates a heat request
8	Time of day (00:00...23:59 format)
9	Indicates first switch-on/off time
10	Indicates second switch-on/off time

RDJ100 Elements	Functions
11	Time setting position
12	First switch-on time
13	First switch-off time
14	Second switch-on time
15	Second switch-off time
16	Comfort temperature setting
17	Energy saving temperature setting
18	RUN position
19	Program slider
20	Advance button (override / presence button)
21	Temperature setting knob
22	Battery compartment
23	Operating mode slider
24	Indicates that programming is taking place
25	 Frost protection; control to a preset temperature setpoint of 5 °C for frost protection
26	 Energy saving mode; continuous control to the energy saving temperature setpoint
27	 Comfort mode; continuous control to the comfort temperature setpoint
28	 Automatic mode; the device operates as per the selected program

## Product documentation

Topic	Title	Document ID:
Operating	Operating instructions	A6V101035986
Installation	Mounting instructions	A6V10974419
CE declaration		A6V101123363

Related documents such as CE declarations, etc., can be downloaded from the following address: <http://siemens.com/bt/download>.

## Notes

### Disposal





The device is considered an electronic device for disposal in accordance with the European Guidelines and may not be disposed of as domestic garbage.

- Dispose of the device through channels provided for this purpose.
- Comply with all local and currently applicable laws and regulations.
- Dispose of empty batteries in designated collection points.



## Instructions for the replacement of alkaline batteries

	<b>⚠ WARNING</b>
	<b>Explosion due to fire or short-circuit, even with discharged batteries</b> Risk of injury due to flying parts <ul style="list-style-type: none"><li>• Prevent the batteries from coming into contact with water.</li><li>• Do not recharge batteries.</li><li>• Do not damage or disassemble batteries.</li><li>• Do not heat batteries over 85°C.</li></ul>

	<b>⚠ WARNING</b>
	<b>Leakage of electrolyte</b> Severe burns <ul style="list-style-type: none"><li>• Handle damaged batteries only wearing suitable protective gloves.</li><li>• In case of contact with electrolyte, rinse eyes immediately with plenty of water. Consult a doctor.</li></ul>

Observe the following:

- Use only a battery of the same type and from the same manufacturer as a replacement.
- Observe the polarities (+/-).
- The batteries must be new and undamaged.
- Do not mix new and used batteries.
- Store, transport and dispose of the batteries in compliance with local requirements, regulations and laws. Also observe the instructions of the battery manufacturer.

### Mounting

When mounting the device, attach the baseplate first. Then make the electrical connections, and fit and secure the device (refer to the separate mounting instructions A6V10974419). Mount the device on a flat wall and in compliance with local regulations.

If the reference room contains thermostatic radiator valves, set them to their fully open position.

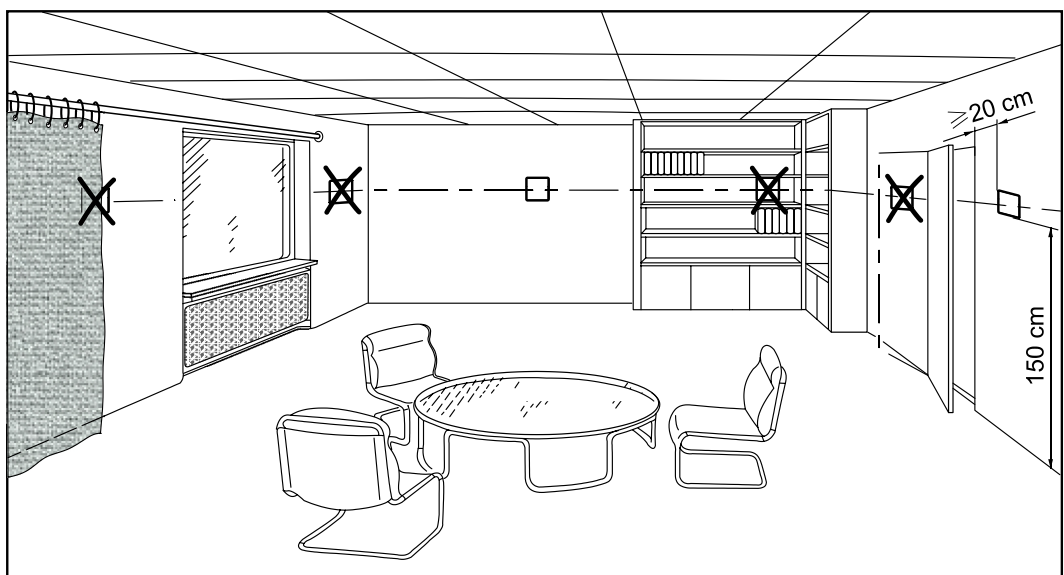

- The devices are suitable for wall mounting.
- Recommended height: 1.5 m above the floor.

- Do not mount the devices in recesses, shelves, behind curtains or doors, or above or near heat sources.
- Avoid direct solar radiation and drafts.
- Seal the conduit box or the installation tube if any, as air currents can affect sensor readings.
- Adhere to allowed ambient conditions.

## Installation

	<b>⚠ WARNING</b>
	<p><b>No internal line protection for supply lines to external consumers.</b> Risk of fire and injury due to short-circuits!</p> <ul style="list-style-type: none"> <li>• Adapt the line diameters as per local regulations to the rated value of the installed overcurrent protection device.</li> <li>• The power supply lines must have an external circuit breaker with a rated current of max. 10 A.</li> </ul>

## Change of batteries

If the battery symbol appears, the batteries are almost empty and must be replaced.

## Reset

To reset, press the reset button on the rear of the device. This resets all individual settings to their default values.

## Maintenance

The device is maintenance-free.

## Technical data

Power supply		
Operating voltage		DC 3 V (2 x 1.5 V AA alkaline batteries)
Battery life		>1 year (with AA alkaline batteries)

Internal sensor inputs		
Thermistor		10 kΩ ± 1% at 25 °C

Switching outputs (Lx, L1, L2)		
Relay contacts	Switching voltage	Max. AC 250 V Min. AC 24 V
	Switching current	Max. 5 A res., 2 A ind.
	At AC 250 V	Min. 8 mA
Insulating strength	Between relay contacts and coil	AC 3,750 V
	Between relay contacts (same pole)	AC 1,000 V

**⚠ WARNING****No internal fuse**

External preliminary protection with max. C 10 A circuit breaker in the supply line required under all circumstances.

**Operational data**

PID control:	Slow	Fast
Minimum switch on/off time	4 min	2 min
Minimum period time	12 min	6 min
Setpoint setting range	5...30 °C (Comfort mode) 5...30 °C (Energy saving mode) 5 °C (Frost Protection, fixed value)	
Factory setting comfort setpoint	20 °C	
Factory setting for energy saving mode	10 °C	
Resolution of settings and displays	Temperature setpoint	0.5 °C
	Display of actual temperature value	0.5 °C

**Electrical connections**

Connections terminals (via baseplate)	Screw terminals
For solid wires	2 x 1.5 mm <sup>2</sup>
For stranded wires	1 x 2.5 mm <sup>2</sup> (min. 0.5 mm <sup>2</sup> )

**Environmental conditions**

Operation	IEC 60721-3-3
Climatic conditions	Class 3K5
Temperature	0...+40 °C
Humidity	<90% r.h.
Transport	IEC 60721-3-2
Climatic conditions	Class 2K3
Temperature	-25...+60 °C
Humidity	<95% r.h.
Mechanical conditions	Class 2M2
Storage	IEC 60721-3-1
Climatic conditions	Class 1K3
Temperature	-10...+60 °C
Humidity	<90% r.h.

**Standards, directives and approvals**

EU conformity (CE)	A6V101123363 *)
RCM conformity	A6V11161600 *)
Safety class	II as per EN 60730-1

Standards, directives and approvals	
Pollution degree	2
Degree of protection of housing	IP20
Environmental compatibility	The product environmental declaration (A6V101123358 *) contains data on environmentally compatible product design and assessments (RoHS compliance, materials composition, packaging, environmental benefit, disposal).

\*) The documents can be downloaded from <http://siemens.com/bt/download>.

Eco design and labeling directives			
ErP class 4	Based on EU Regulation 813/2013 (Eco design directive) and 811/2013 (Labeling directive) concerning space heaters, the following classes apply:		
	Application with On/Off operation of a heater	Class I	Value 1%
	PWM (TPI) room thermostat, for use with On/Off output heaters	Class IV	Value 2%

General	
Weight (including package)	350 g
Color of housing front	Signal-white RAL9003
Housing material	ABS (LCD lens:PC)

## Connection diagram

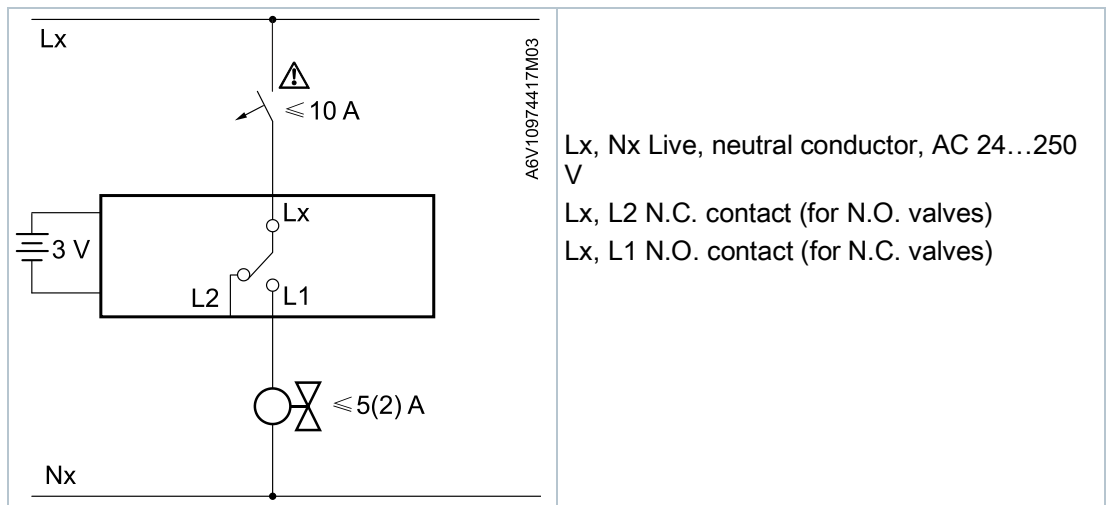

## Application examples

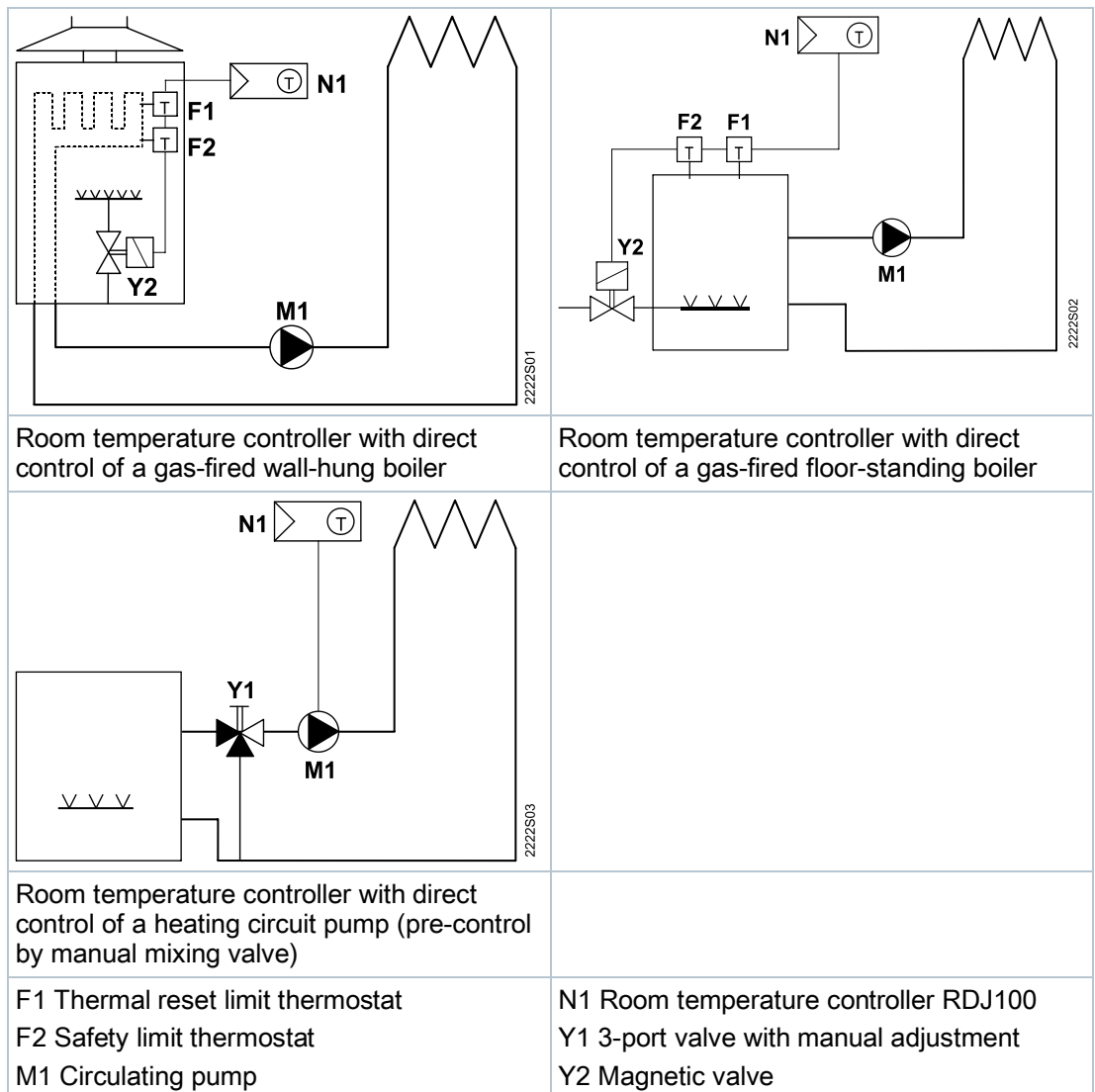

## Dimensions

[mm]

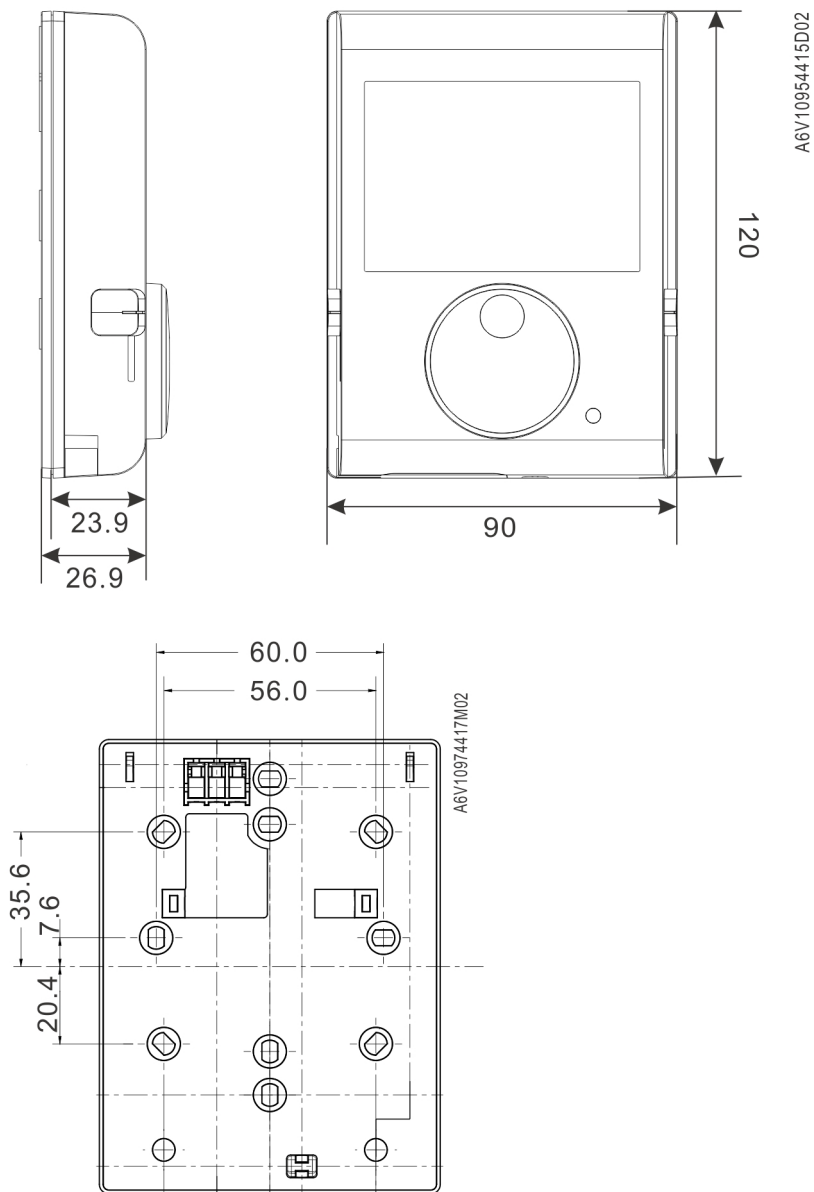

## Product history

Index 1)	Date	Changes
≥C	June 2018	<ul style="list-style-type: none"> <li>Add new function min/max temperature limitation, selectable control behavior, parameter settings and service interval reminder.</li> </ul>
Z, A	March 2017	First release.

1) Product index can be found next to the production date on the rear of the device "YYMMDDX".



Issued by  
Siemens Switzerland Ltd  
Building Technologies Division  
International Headquarters  
Theilerstrasse 1a  
CH-6300 Zug  
Tel. +41 58 724 2424  
[www.siemens.com/buildingtechnologies](http://www.siemens.com/buildingtechnologies)

© Siemens Switzerland Ltd, 2017  
Technical specifications and availability subject to change without notice.