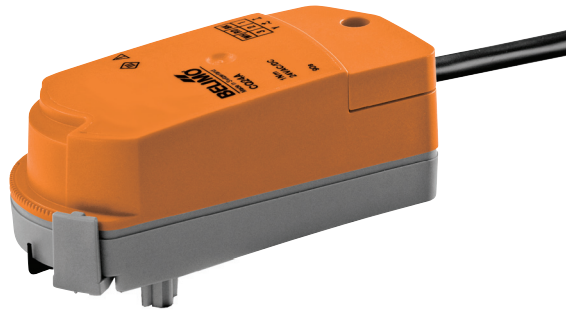

**Rotary actuator, for 2-way zone valves (C215Q)**

- Nominal voltage AC/DC 24 V
- Control: Open-close, 3-point
- Snap-assembly
- kvs variable

**Technical data**

<b>Electrical data</b>	Nominal voltage	AC/DC 24 V
	Nominal voltage frequency	50/60 Hz
	Nominal voltage range	AC 19.2...28.8 V / DC 21.6...28.8 V
	Power consumption in operation	0.3 W
	Power consumption at rest	0.15 W
	Power consumption for wire sizing	0.6 VA
	Connection supply / control	Cable 1 m, 3 x 0.75 mm <sup>2</sup>
	Parallel operation	Yes
<b>Functional data</b>	Manual override	possible, through dismantling of actuator
	Running time motor	90 s / 90° (kvmax = 4.5)
	Sound power level motor max.	35 dB (A)
	Position indication	yes
	kvs (factory setting)	4 m <sup>3</sup> /h
	kvs variable	0.25 / 0.4 / 0.63 / 1 / 1.6 / 2.5 / 4 (4.5 without end stop clip)
<b>Safety</b>	Protection class IEC/EN	III Safety extra-low voltage
	Degree of protection IEC/EN	IP40
	EMC	CE according to 2004/108/EC
	Certification IEC/EN	Certified to: IEC/EN 60730-1 and IEC/EN 60730-2-14
	Principle of operation	Type 1
	Rated impulse voltage supply / control	0.8 kV
	Control pollution degree	3
	Ambient temperature	5...40 °C
	Non-operating temperature	-7...50 °C
	Ambient humidity	95% r.h., non-condensing
Maintenance	Maintenance-free	
<b>Weight</b>	Weight approx.	0.2 kg

**Safety notes**

- This actuator has been designed for application in stationary heating, ventilation and air-conditioning systems and is not allowed to be used outside the specified field of application, especially in aircraft or in any other airborne means of transport.
- Only authorised specialists may carry out installation. All applicable legal or institutional installation regulations must be complied with during installation.
- The device may only be opened at the manufacturer's site. It does not contain any parts that can be replaced or repaired by the user.
- The cable must not be removed from the device.
- The device contains electrical and electronic components and is not allowed to be disposed of as household refuse. All locally valid regulations and requirements must be observed.

**Product features**

- Direct mounting** Tool-free snap-assembly  
The actuator can be plugged to the valve with hand pressure (Caution! vertical movement only). Pins must match the holes on the flange. The mounting orientation in relation to the valve can be selected in 180° increments. (possible 2 x)
- Manual override** Click out the actuator and rotate the valve stem with the help of the actuator.
- High functional reliability** The actuator is overload protected, requires no limit switches in intermediate positions and automatically stops when the end stop is reached (at rest).
- Adjustable angle of rotation** The angle of rotation of the actuator can be changed by clip in 2.5° increments. This is used to set the kvs value (maximum flow rate of the valve).
- kvs setting** Remove end stop clip and place at desired position (without end stop clip kvs = 4.5 m³/h).

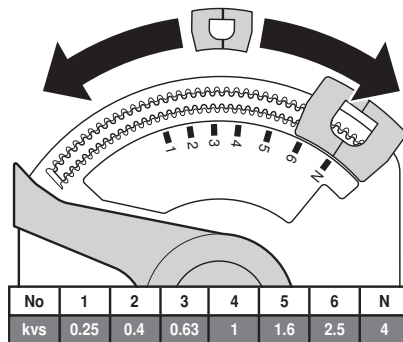

**Accessories**

	Description	Type
Mechanical accessories	Housing cover white	ZCQ-W

**Electrical installation**

**Wiring diagrams**

**AC/DC 24 V, open/close**

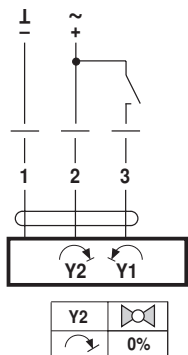

**Cable colours:**  
1 = black  
2 = red  
3 = white

**AC/DC 24 V, 3-point**

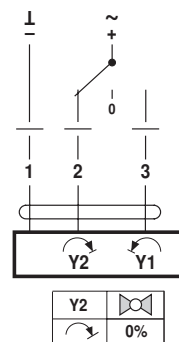

**Cable colours:**  
1 = black  
2 = red  
3 = white

## Dimensions [mm]

## Dimensional drawings

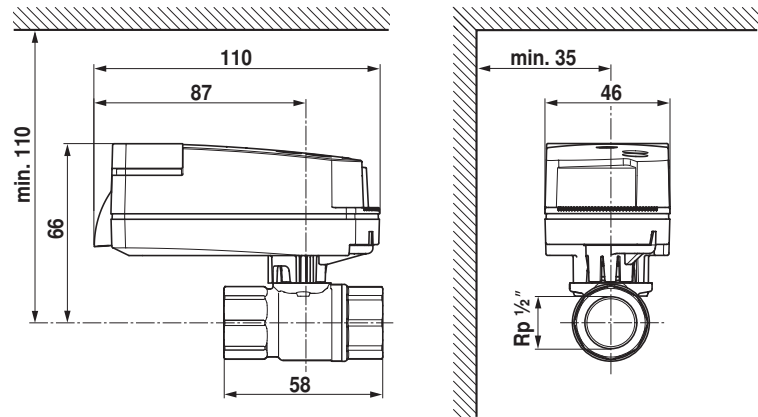

## Further documentation

- Installation instructions for actuators and/or butterfly valves and rotary valves, respectively

71406-00001.H

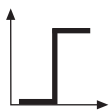
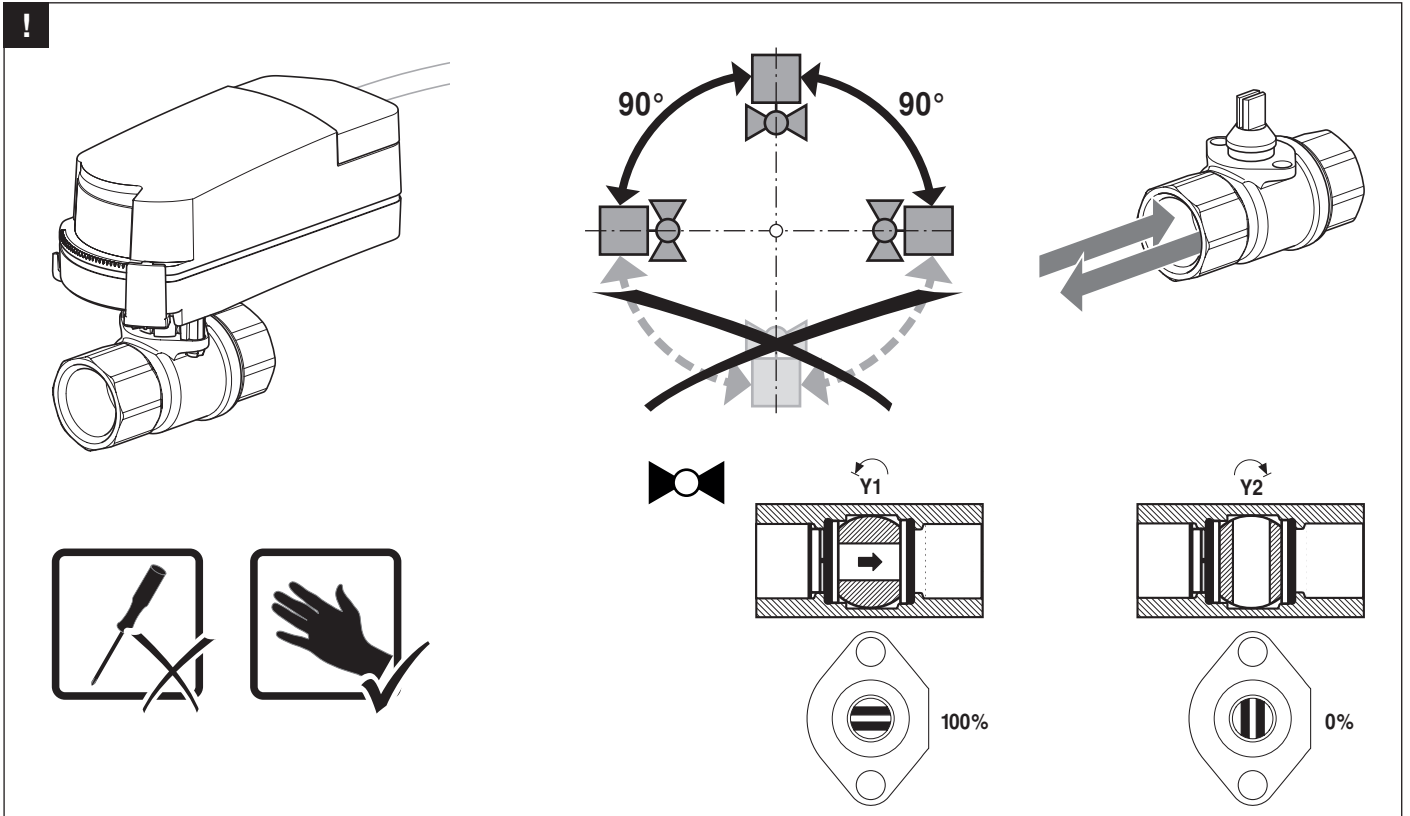

AC 24 V / DC 24 V

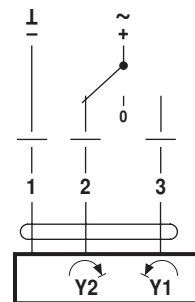
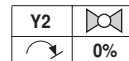
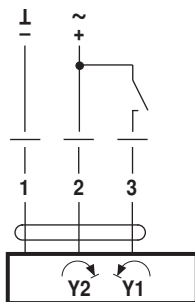

AC 100 ... 240 V ⚠

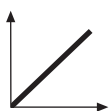
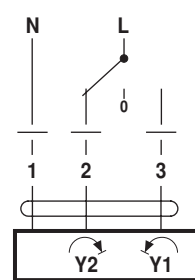
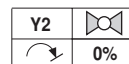
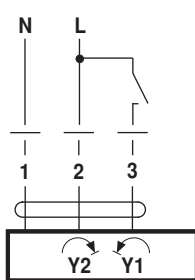

AC 24 V / DC 24 V

